

**1. Function**

Photoluminescent Floor Proximity Emergency Escape Path Marking (PL-FPEEPM) is based on the use of a material which is able to store natural or electrical light energy, and to restore this energy gradually in the form of light in the dark.

The global system characteristics depends of the initial lighting conditions.

PL-FPEEPM system does not require a power supply, is not subject to breakdown or failure and improves the reliability of the emergency lighting system.

System proposed by Madelec Aero meets FAR/JAR 25 and AC25.812-2 requirements.

**2. Main Characteristics**

**The photoluminescent material without filter is used is non-radioactive.**

The relationship between charge conditions and light autonomy is given in the following table.

Charge conditions		Light Autonomy	
Light level (Lux)	Charge time (mins.)	Autonomy (hours)	Disch. luminance (mcd/m <sup>2</sup> )
50	15	6.5	1.91
25	30	4.5	2.93
30	30	5.5	3.04
40	30	10	1.5
25	45	12	1.33

**3. Form & Dimensions**

System consists of a 3 cm wide flexible photoluminescent tape assembled with a polycarbonate profile.

Three profile types are available :

- A "flush profile" : 505 type.
- A "overlap profile" : 507 type.
- A "very low profile" : 503 type.

The two first types are consisted of a four components system fitted together and the first type is a single-piece component and intended to the galley area.

**4. Airworthiness / References**

- Type Certificate  
ATR42 & 72 - Dash8-Q400 – CRJ700.
- Supplemental Type Certificate (EASA)  
A300 - A320 – A321 – A330 - A340 – B737 - DC10 – Fokker F70 & F100 - CRJ500 – Embraer 120 – etc.

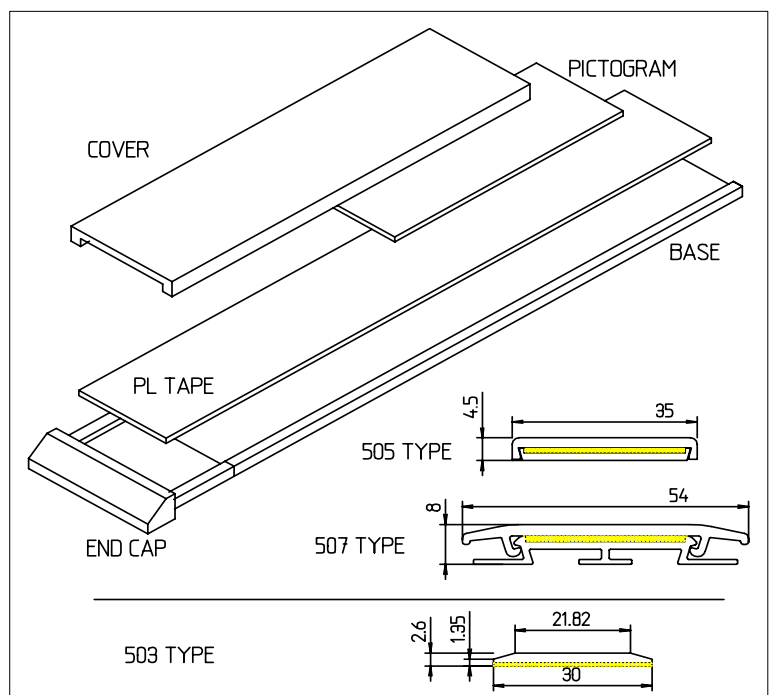











**Photoluminescent Floor Path Marking**

**5. Colours Option**

*Please consult Madelec Aero for any characteristics with filter*

<u>Colour obtained when filter put on photoluminescent tape</u>	<u>Part Number</u>
 106	..... 566-GAM106-020
 325	..... 566-GAM325-020
 343	.....566-GAM343-020
 360	..... 566-GAM360-020
 540	..... 566-GAM0540-020
 725	..... 566-GAM0725-020
 790	..... 566-GAM0790-020
 885	..... 566-GAM0885-020
 920	..... 566-GAM0920-020